

KENWOOD

AV SURROUND PROCESSOR

SS-592

INSTRUCTION MANUAL

KENWOOD CORPORATION

Introduction

Your choice of this product indicates that you are a devotee to excellence in sound reproduction.

We appreciate your patronage and take pride in the long tradition of quality components that our company represents.

So that you can get the most out of your unit, we suggest that you take the time to read through this manual before you hook up and operate your system. This will acquaint you with operating features and system-connection considerations so that your listening pleasure will be enhanced right from the start. You will notice that in all aspects of planning, engineering, styling, operating convenience and adaptability we have sought to anticipate your needs and desires.

Keep this manual handy for future reference.

For your records

Record the serial number, found on the back of the unit, in the spaces designated on the warranty card, and in the space provided below. Refer to the model and serial numbers whenever you call upon your dealer for information or service on this product.

Model _____ Serial Number _____

Unpacking

Unpack the unit carefully and make sure that all accessories are put aside so they will not be lost.

Examine the unit for any possibility of shipping damage. If your unit is damaged or fails to operate, notify your dealer immediately. If your unit was shipped to you directly, notify the shipping company without delay. Only the consignee (the person or company receiving the unit) can file a claim against the carrier for shipping damage.

We recommend that you retain the original carton and packing materials for use should you transport or ship the unit in the future.

Manufactured under license from Dolby Laboratories Licensing Corporation. Additionally licensed under one or more of the following patents : U.S. numbers 3,632,886, 3,746,792 and 3,959,590 ; Canadian numbers 1,004,603 and 1,037,877. "Dolby" and the double-D symbol  are trademarks of Dolby Laboratories Licensing Corporation.



Accessories

Audio cord 2 System control cord 1



Contents

Caution : Read the pages marked  carefully to ensure safe operation.

Introduction	2	Controls and indicators	7
 Before applying power	3	Surround Play	8
 Safety precautions	3	Dolby Surround Play	9
 IMPORTANT SAFEGUARDS	4	THEATER, HALL Surround Play	10
System connections	6	In case of difficulty	11
Connection with KA-892 or KC-992	6	Specifications	11
Connection with an ordinary amplifier or receiver	7		

⚠ Caution: Read this page carefully to ensure safe operation.

Before applying power

For the U.S.A. and Canada

Important!

Units shipped to the U.S.A. and Canada are designed for operation on 120 volts AC only.

CAUTION: TO PREVENT ELECTRIC SHOCK DO NOT USE THE AC PLUG WITH AN EXTENSION CORD, RECEPTACLE OR OTHER OUTLET UNLESS THE BLADES CAN BE FULLY INSERTED TO PREVENT BLADE EXPOSURE.

For the United Kingdom

Important!

Units shipped to the U.K. are designed for operation on 240 volts AC only.

The mains plug must be removed from the wall socket prior to any internal examination.

The wires in this mains lead are coloured in accordance with the following code:

Blue Neutral
Brown Live

The wires in this mains lead must be connected to the terminals in the plug as follows:

Wire colour	Plug terminal marking
Blue	N or Black
Brown	L or Red

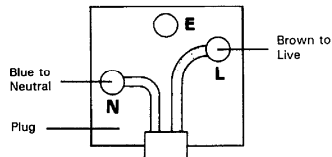

Notes:

1. If a 13-amp plug is used, this must be fitted with a 5-amp fuse.
2. If a 3-pin plug with earthing contact is used, no wire must be connected to the E terminal.

For Australia and Europe

Important!

Units shipped to Australia are designed for operation on 240 V AC only.

Units shipped to Europe are designed for operation on 230 V AC only.

For other countries

Important!

Units shipped to countries other than the above countries are equipped with an AC voltage selector switch on the rear panel. Refer to the following paragraph for the proper setting of this switch.

AC voltage selection

This unit operates on 110-120 or 220-240 volts AC. The AC voltage selector switch Type A or Type B on the rear panel is set to the voltage that prevails in the area to which the unit is shipped. Before connecting the power cord to your AC outlet, make sure that the setting position of this switch matches your line voltage. If not, it must be set to your voltage in accordance with the following direction.

Note:

Our warranty does not cover damage caused by excessive line voltage due to improper setting of the AC voltage selector switch.

AC voltage selector switch

Type A

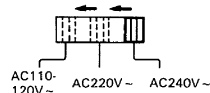

Type B

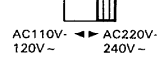

Move switch lever to match your line voltage with a small screwdriver or other pointed tool.

Safety precautions

WARNING: TO PREVENT FIRE OR ELECTRIC SHOCK, DO NOT EXPOSE THIS APPLIANCE TO RAIN OR MOISTURE.

	<p>CAUTION: TO REDUCE THE RISK OF ELECTRIC SHOCK, DO NOT REMOVE COVER (OR BACK). NO USER-SERVICEABLE PARTS INSIDE, REFER SERVICING TO QUALIFIED SERVICE PERSONNEL.</p>
	<p>THE LIGHTNING FLASH WITH ARROWHEAD SYMBOL, WITHIN AN EQUILATERAL TRIANGLE, IS INTENDED TO ALERT THE USER TO THE PRESENCE OF UNINSULATED "DANGEROUS VOLTAGE" WITHIN THE PRODUCT'S ENCLOSURE THAT MAY BE OF SUFFICIENT MAGNITUDE TO CONSTITUTE A RISK OF ELECTRIC SHOCK TO PERSONS.</p>
	<p>THE EXCLAMATION POINT WITHIN AN EQUILATERAL TRIANGLE IS INTENDED TO ALERT THE USER TO THE PRESENCE OF IMPORTANT OPERATING AND MAINTENANCE (SERVICING) INSTRUCTIONS IN THE LITERATURE ACCOMPANYING THE APPLIANCE.</p>

IMPORTANT SAFEGUARDS

⚠ Caution : Read this page carefully to ensure safe operation.

Please read all of the safety and operating instructions before operating this unit. For best results, follow all warnings placed on the unit and adhere to the operating and use instructions. These safety and operating instructions should be retained for future reference.

1. Power sources — The unit should be connected to a power supply only of the type described in the operating instructions or as marked on the appliance.

2. Power-cord protection — Power-supply cords should be routed so that they are not likely to be walked on or pinched by items placed upon or against them, pay particular attention to cords at plugs, convenience receptacles, and the point where they exit from the unit.

Never pull or stretch the cord.



3. Grounding or polarization — The precautions should be taken so that the grounding or polarization means of this unit is not defeated.

4. Ventilation — The unit should be situated so that its location or position does not interfere with its proper ventilation.

To maintain good ventilation, do not put records or a table-cloth on the unit. Place the unit at least 10 cm away from the walls.

Do not use the unit on a bed, sofa, rug or similar surface that may block the ventilation openings.



5. Water and moisture — The unit should not be used near water — for example, near a bathtub, washbowl, kitchen sink, laundry tub, in a wet basement, or near a swimming pool, etc.

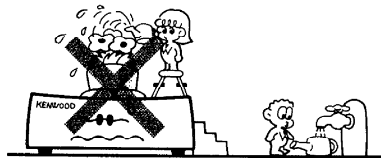

6. Temperature — The unit may not function properly if used at extremely low, or freezing temperatures. The ideal ambient temperature is above +5°C (41°F).

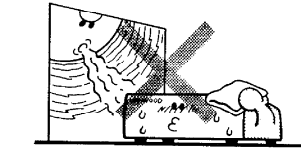

7. Heat — The unit should be situated away from heat sources such as radiators, heat registers, stoves, or other units (including amplifiers) that produce heat.

8. Electric shock — Care should be taken so that objects do not fall and liquid is not spilled into the enclosure through openings. If a metal object, such as a hair pin or a needle, comes into contact with the inside of this unit, a dangerous electric shock may result. For families with children, never permit children to put anything, especially metal, inside this unit.

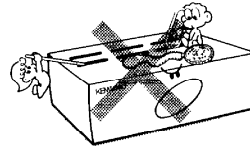

9. Enclosure removal — Never remove the enclosure. If the internal parts are touched accidentally, a serious electric shock might occur.

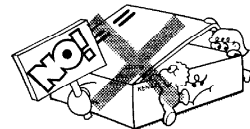

10. Magnetic fields — Keep the unit away from sources of magnetic fields such as TV sets, speaker systems, radios, motorized toys or magnetized objects.

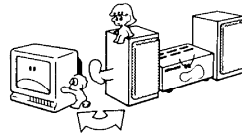

11. Cleaning — Do not use volatile solvents such as alcohol, paint thinner, gasoline, or benzene, etc. to clean the cabinet. Use a clean dry cloth.

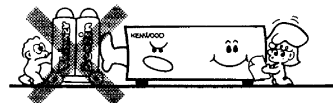

⚠ Caution : Read this page carefully to ensure safe operation.

12. Carts and stands — An appliance and cart combination should be moved with care. Quick stops, excessive force, and uneven surfaces may cause the appliance and cart combination to overturn.



13. Nonuse periods — The power cord of the unit should be unplugged from the outlet when left unused for a long period of time.

14. Abnormal smell — If an abnormal smell or smoke is detected, immediately turn the power OFF and pull out the power cord. Contact your dealer or nearest service center.

POWER OFF!

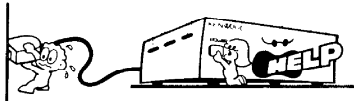

15. Damage requiring service — The unit should be serviced by qualified service personnel when:

- A. The power-supply cord or the plug has been damaged; or
- B. Objects have fallen, or liquid has been spilled into the unit; or
- C. The unit has been exposed to rain; or
- D. The unit does not appear to operate normally or exhibits a marked change in performance; or
- E. The unit has been dropped, or the enclosure damaged.

16. Servicing — The user should not attempt to service the unit beyond that described in the operating instructions. All other servicing should be referred to qualified service personnel.

17. Outdoor antenna grounding — If an outside antenna is connected to the receiver, be sure the antenna system is grounded so as to provide some protection against voltage surges and built up static charges. Section 810 of the National Electrical Code, ANSI/NFPA 70, provides information with respect to proper grounding of the mast and supporting structure, grounding of the lead-in wire to an antenna discharge unit, size of grounding con-

ductors, location of antenna-discharge unit, connection to grounding electrodes, and requirements for the grounding electrode. See Figure.

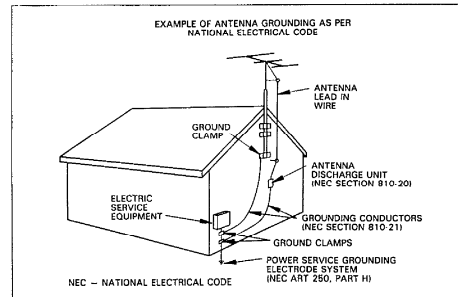

18. Power lines — An outdoor antenna should be located away from power lines.

19. AC outlets — Do not connect other audio equipment with a power consumption larger than that specified to the AC outlet on the rear panel. Never connect other electrical units, such as an iron or toaster, to it to prevent fire or electric shock.

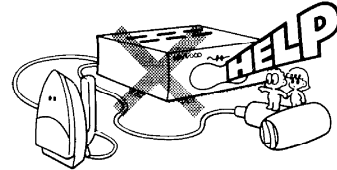

Notes:

- 1. Item 3 is not required except for grounded or polarized equipment.
- 2. Item 17 and 18 are not required except for units provided with antenna terminals.
- 3. Item 17 complies with UL in the U.S.A.

System connections

Make connections as shown below. When connecting the related system components, refer also to the instruction manuals of the related components.

Do not plug in the power lead until all connections are completed.

■ Connection with KA-892 or KC-992

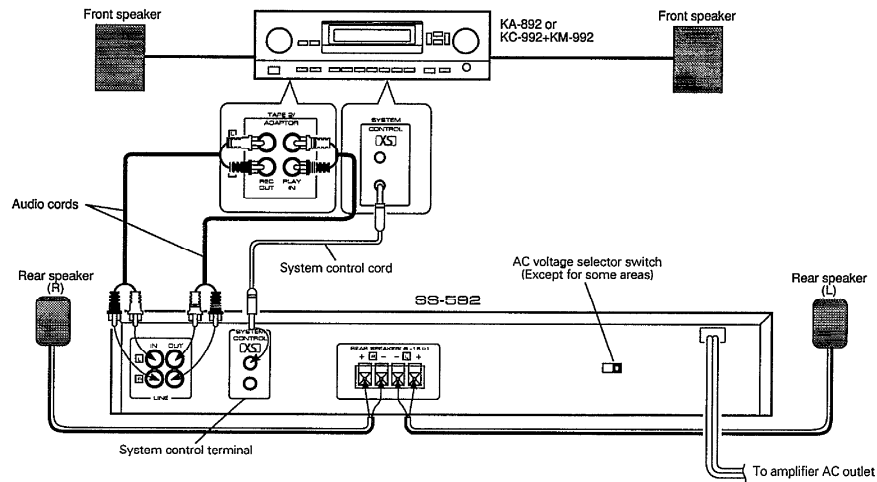

System control connection

- Be sure to insert the system control cord plugs fully into the SYSTEM CONTROL terminals.
- If the system control cord and audio cords are not connected properly, the automatic system governing remote control and system functions will not operate.

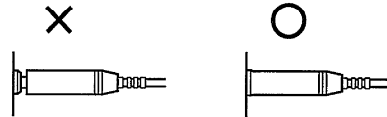

Preparations for operation A:

When this unit is connected to the TAPE 2/ADAPTOR jacks of the amplifier KA-892 or KC-992

- ① Set the switch on the amplifier rear panel to ADAPTOR. (The switch position should be changed while the power is OFF.)
- ② Turn the powers of the components to ON.
- ③ Press the TAPE 2/ADAPTOR key on the amplifier front panel so that [ADAPTOR] lights up.



- The VOLUME CONTROL of the amplifier is set automatically to the center position in about 20 seconds. The keys are invalid in this period. (When a CD player or cassette deck is turned ON/OFF during using this unit, this will occur.)
- The overall volume is to be adjusted with the MASTER LEVEL of this unit or with the remote control provided with the amplifier.
- When this unit is not to be used, press the TAPE 2/ADAPTOR key on the amplifier front panel so that [ADAPTOR] goes out.

Notes:

1. Connect all cords firmly. If connections are loose, there could be loss of sound or noise produced.
2. When plugging and unplugging connection cords, be sure to first remove the power cord from the AC outlet. Plugging/unplugging connection cords without removal of the power cord can cause malfunctions or damage to the unit.

■ Connection with an ordinary amplifier or receiver

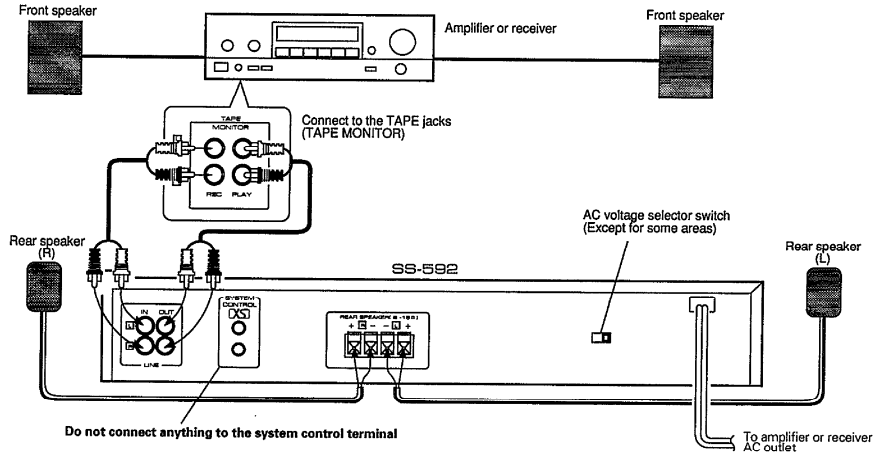

Preparations for operation B: When this unit is connected to an ordinary amplifier or receiver

- ① Turn the powers of the components to ON.
- ② Set the TAPE MONITOR switch of the amplifier or receiver to the monitoring (ON) position.
- ③ Set the volume control of the amplifier or receiver to around the center position.
 - The overall volume is to be adjusted with the MASTER LEVEL of this unit.

Speaker connections

- ① Remove insulation.
 - ② Twist wire tightly.
 - ③ While pressing lever (holding it).
 - ④ Insert the wire.
 - ⑤ Release lever.
-

- Connect speakers rated at 8 ohm or more to the SPEAKERS terminals.
- Never short-circuit the + and - speaker cords.
- If the left and right speakers are connected inversely or if the speaker cords are connected with reversed polarity, the sound becomes unnatural with ambiguous acoustic image positioning. Be sure to connect the speakers and speaker cords correctly.

Controls and indicators

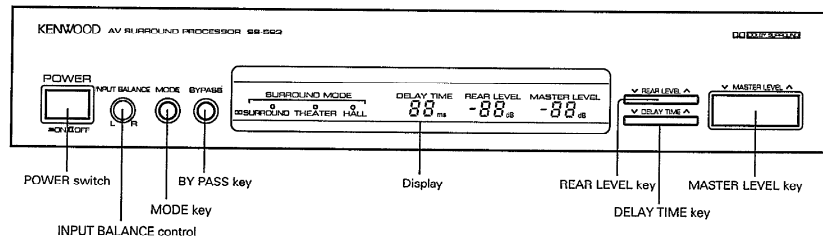

Surround Play

This system incorporates the following Surround functions which can provide the feeling of presence in a concert hall or theater or the powerful effects of theater movies recorded with Dolby Surround audio.

1. DOLBY SURROUND :

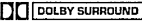
When video software carrying "  " mark is played, this mode provides the similar Dolby Surround effect to movie theaters.

2. THEATER :

A natural reverberation effect, like when viewing a movie in a movie theater, can be obtained with sources which are not recorded with Dolby Surround.

3. HALL :

A powerful sound effect, as if the listener is in a concert hall, can be obtained.

Speaker arrangements

Surround (rear) speakers can be placed with various arrangements according to the listening room size and its reverberation characteristics. The example shown in the illustration is a typical example among several arrangements which allow efficient enjoyment of Surround effects. In addition to it, other arrangements are also possible. Please install the rear speakers according to your individual taste as well as to the listening room.

Standard layout

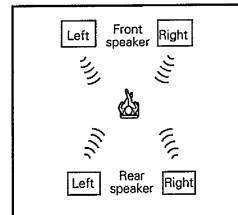

Delay time

As shown in the example of illustration, the sound of piano played on the stage attains the ears of listener as a synthesis of the direct sound from piano, the indirect sounds which are reflected once or twice by the reflectors, ceiling and side and back walls, and the reverberation sounds which repeat infinite reflections until they fade out completely.

The indirect sounds always pass through longer routes compared to the direct sound. The delay between the direct and indirect sounds is called the DELAY TIME, and the level of the indirect or reverberated sounds is called the PRESENCE LEVEL.

The indirect sounds accompanied with delay play a very important role in providing better sound effects and the feeling of presence of concert halls, etc. The acoustic field also varies depending on the speaker arrangement. It is recommended to try various delay time setting to obtain the best sound field possible.

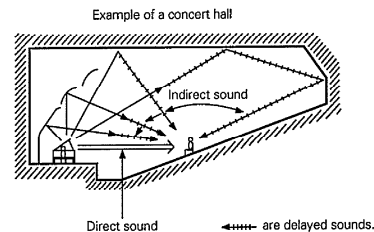

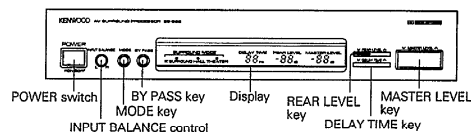

■ Dolby Surround play

Preparations : Complete the "Preparations of operation A or B" on page 6 or 7 before proceeding to the following.

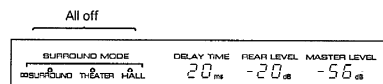

Initial state when power is turned ON. The last state is not backed up (stored) in memory.

1 Select the DOLBY SURROUND.

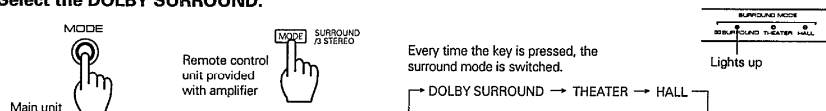

2 Set the delay time.

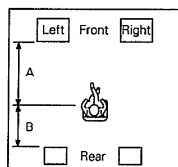
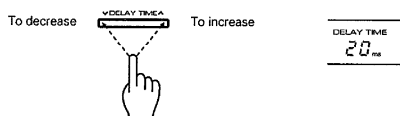

$$\text{Delay time (ms)} = 20\text{ms} + 3\text{ms} (A - B)$$

A : Distance of front speaker (m)
B : Distance of rear speaker (m)

- Calculate the proper delay time for Dolby Surround by referring to the illustration below.
- The delay time can be adjusted in the range from 15 to 30 ms.
- Holding the key depressed varies the value at high speed.

3 Adjust the Dolby Surround input balance.

- 1 Play the video software with the Dolby Surround.
- 2 Adjust the balance between the left and right inputs.
- 3 Stop playing the video software.

- Play the scene with a lot of dialogues in the video software to be watched.

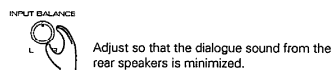

4 Play Dolby Surround video software.

- 1 Play video software recorded with Dolby Surround.
- 2 Adjust the listening volume.
- 3 Adjust the rear speaker volume.



- Holding the key depressed varies the volume at high speed.

To return to normal stereo playback from Dolby Surround playback

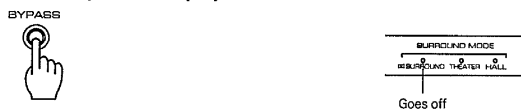

- To restart Surround playback, press the [MODE] key shown in step 1.

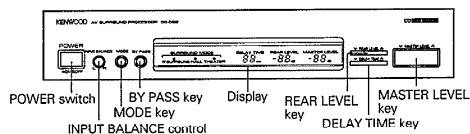

THEATER, HALL Surround Play

Preparations : Complete the "Preparations of operation A or B" on page 6 or 7 before proceeding to the following.



Initial state when power is turned ON. The last state is not backed up (stored) in memory.

1 Select the Surround mode.

Select THEATER or HALL.

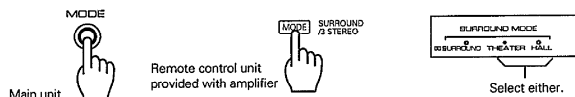

Every time the key is pressed, the surround mode is switched.

- When a source is played in monaural, select "HALL".

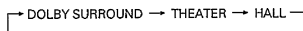

2 Set the delay time.

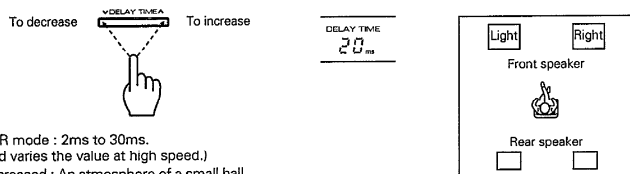

- Variation range in THEATER mode : 2ms to 30ms. (Holding the key depressed varies the value at high speed.)
When the delay time is decreased : An atmosphere of a small hall, for example a jazz club, can be obtained.
When the delay time is increased : An atmosphere of a large hall, for example a concert hall, can be obtained.
- Delay time in HALL mode : Fixed at 20ms (not variable).

3 Play a music source.

① Play a music source.

② Adjust the listening volume.

③ Adjust the rear speaker volume.



- Holding the key depressed varies the volume at high speed.

To return to normal stereo playback from Surround playback



- To restart Surround playback, press the **MODE** key shown in step 1.

In case of difficulty

What appears to be a malfunction may not always be serious. If your unit should not perform as expected, consult the table below to see if the problem can be corrected before seeking help from your dealer or service representative.

Symptom	Cause	Remedy
Sound is not output.	<ul style="list-style-type: none"> The speaker cords are disconnected. The VOLUME is set to the minimum position. The audio cords are disconnected. 	<ul style="list-style-type: none"> Connect them properly referring to "System connections". Adjust the volume to a proper level. Check the audio cords connections.
Sound is not output from the Surround rear speaker and/or their sound is very small.	<ul style="list-style-type: none"> The rear-speaker cords are disconnected. The REAR LEVEL is set to the minimum level. The BYPASS mode has been set. The audio source is monaural. (When the audio source is monaural, sound is not output from the rear speakers when the unit is set to the DOLBY SURROUND or THEATER surround position.) The TAPE 2/ADAPTOR key on the amplifier (KA-892, KC-992) front panel is not depressed. 	<ul style="list-style-type: none"> Connect them properly referring to "System connections". Adjust the REAR LEVEL controls. Select a Surround mode (DOLBY SURROUND, HALL or THEATER). Set the surround position to HALL. Press the TAPE 2/ADAPTOR key so that [ADAPTOR] lights up.
Remote control unit provided with the amplifier (KA-892, KC-992) cannot be used.	<ul style="list-style-type: none"> The TAPE 2/ADAPTOR switch on the amplifier rear panel is set to TAPE. The system control cords are disconnected. 	<ul style="list-style-type: none"> Set to ADAPTOR. Connect them properly referring to "System connections".

Notes:

- This system is microprocessor-controlled, so malfunction may occur due to external noise or interference noise. In such a case, unplug the power cord, plug it and turn power on again.
- Do not use contact cleaners because it could cause a malfunction. Be specially careful against contact cleaners containing oil, for they may deform the plastic components.

Specifications

Power Output

Continuous Rated Power Output (FTC)

12 watts per channel minimum RMS, both channels driven, at 8 Ω, 1 kHz with no more than 0.9 % total harmonic distortion.

Frequency Response

(LINE OUT) 20 Hz ~ 40 kHz, 0 dB, -3 dB

Signal to Noise Ratio

(LINE OUT) 95 dB (IHF A)

Input Sensitivity/Impedance 250 mV/47 kΩ

Output Level/Impedance

(LINE OUT) 1 V/2.2 kΩ

General

Power Consumption 0.5 A (U.S.A.)
40 W (Other countries)

Dimensions W: 440 mm (17 - 5/16")
H: 73 mm (2 - 7/8")
D: 264 mm (10 - 3/8")

Weight (Net) 3.5 kg (7.7 lb)

Note:

KENWOOD follows a policy of continuous advancements in development. For this reason specifications may be changed without notice.

**For CANADA
DOC REGULATION**

"This digital apparatus does not exceed the CLASS B limits for radio noise emissions from digital apparatus as set out in the radio interference regulations of the Canadian Department of Communications."

**For the U.S.A.
FCC WARNING:**

This equipment may generate or use radio frequency energy. Changes or modifications to this equipment may cause harmful interference unless the modifications are expressly approved in the instruction manual. The user could lose the authority to operate this equipment if an unauthorized change or modification is made.

NOTE:

This equipment has been tested and found to comply with the limits for a Class B digital device, pursuant to Part 15 of the FCC Rules. These limits are designed to provide reasonable protection against harmful interference in a residential installation. This equipment may cause harmful interference to radio communications, if it is not installed and used in accordance with the instructions. However, there is no guarantee that interference will not occur in a particular installation. If this equipment does cause harmful interference to radio or television reception, which can be determined by turning the equipment off and on, the user is encouraged to try to correct the interference by one or more of the following measures:

- — Reorient or relocate the receiving antenna.
- — Increase the separation between the equipment and receiver.
- — Connect the equipment into an outlet on a circuit different from that to which the receiver is connected.
- — Consult the dealer or an experienced radio/TV technician for help.